

This manual is for reference and historical purposes, all rights reserved.

This page is copyright© by M. Butkus, NJ.

This page may not be sold or distributed without the expressed permission of the producer
I have no connection with any camera company

On-line camera manual library

This is the full text and images from the manual. This may take 3 full minutes for the PDF file to download.

If you find this manual useful, how about a donation of \$3 to: M. Butkus, 29 Lake Ave., High Bridge, NJ 08829-1701 and send your e-mail address so I can thank you. Most other places would charge you \$7.50 for a electronic copy or \$18.00 for a hard to read Xerox copy.

This will allow me to continue to buy new manuals and pay their shipping costs.

It'll make you feel better, won't it?

**If you use Pay Pal or wish to use your credit card,
click on the secure site on my main page.**

PayPal Name Lynn@butkus.org

k St

Canon

EOS

REBELG / REBELG QD



E

English Edition
INSTRUCTIONS

Thank you for purchasing a Canon product.



The EOS is a very compact autofocus, single-lens reflex camera. It has many basic and advanced picture-taking modes to suit various picture-taking requirements.

Try out your new camera while following the instructions in this booklet.

● Precautions

- Before using the camera for an important event such as a wedding, be sure to take test shots to make sure the camera operates properly.
- EOS cameras have a lens mount fitted with electronic contacts for dedicated operation (autofocusing, exposure control, etc.) with EF lenses. Using a non-EF lens with an EOS camera may not result in proper camera or lens operation. Also, the warranty does not cover any camera malfunction or damage occurring with the use of non-Canon accessories.

Symbols used in this Instructions:

-  : Warning for preventing camera malfunction or damage.
-  : Supplementary notes for basic camera operation.
-  : Helpful tip for operating your camera and taking pictures.
- Page numbers in parentheses indicate where you can find more information.
- Also read "Handling Precautions" on page 62 to prevent camera malfunction and damage.
- Retain this Instructions for future reference.

I. Before You Start

II. Basic Operation

III. Self-Timer and Quartz Date (QD model only)

IV. Advanced Operations

V. E-TTL Autoflash

VI. Reference

Quick Start Guide	4	Viewfinder Information.....	8
Nomenclature	6	Command Dial.....	9
LCD Panel	8		
Attaching the neck strap	10	Shutter Button and Autofocusing Operations.....	13
Installing the Batteries and Checking the Battery Level	10	Loading and Unloading Film.....	14
Mounting and Detaching a Lens....	12		
□ Full Auto Mode	16	✿ Close-up Mode	22
Setting Red-Eye Reduction	18	🏃 Sports Mode	23
👤 Portrait Mode	20	🌃 Night Scene Mode	24
🏞 Landscape Mode	21		
Self-timer Operation	25	Replacing the Quartz Date Battery	27
Imprinting the Date or Time	26		
Setting the Date and Time	27		
Focusing Point Selection	28	Partial Metering and AE Lock	42
Focusing an Off-Center Subject	30	Exposure Compensation	43
📷 Program AE.....	31	📷 Autoexposure Bracketing (AEB)..	44
📷 Shutter-Speed Priority AE.....	33	<i>bulb</i> Bulb Exposure	46
📷 Aperture-Priority AE.....	35	📷 Multiple Exposures	47
📷 Manual Exposure	37	ISO Setting the ISO Film Speed.....	49
📷 Automatic Depth-of-Field AE ...	38	🔊 Silencing the In-Focus Beeper ..	50
📷 Using the Built-in Flash	39	🔄 Midroll Film Rewind	51
📷 TTL Autoflash with EX-Series Speedlites	52		
Basic Terminology	56	Major Accessories	61
Troubleshooting Guide	58	Handling Precautions	62
Exposure Warnings	59	Major Specifications	64
Feature Availability Table	60		
AF Modes and Film Advance Modes	60		

Quick Start Guide

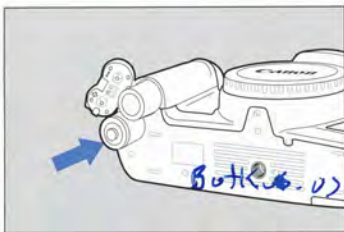

1 Install the batteries.

As shown in the figure, open the battery compartment cover and insert two DL123A (or CR123A) lithium batteries.

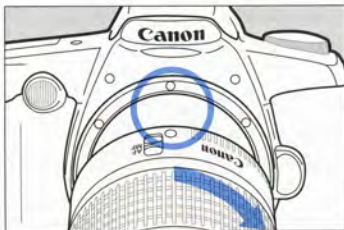

2 Attach a lens.

Align the red dots on the lens and camera and turn the lens clockwise until it snaps in place.



3 On the lens, set the focus mode switch to **AF**.

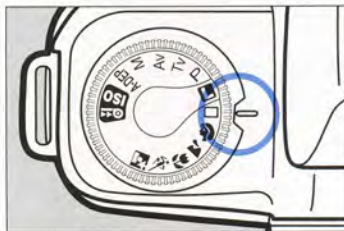

4 Set the Command Dial to □ .

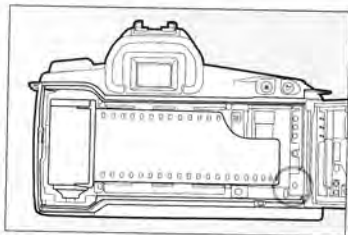

5 Load the film.

Align the edge of the film leader with the orange mark on the camera and close the camera back until it snaps shut. The film will then advance to frame 1 automatically.



6 Focus the subject.

Aim the focusing point (□ □ □) on the subject and press the shutter button lightly to autofocus.



7 Take the picture.

Press the shutter button completely to take the picture.

8 Unloading the film.

At the end of the roll, the film rewinds automatically. Open the camera back and remove the film cartridge.

Nomenclature

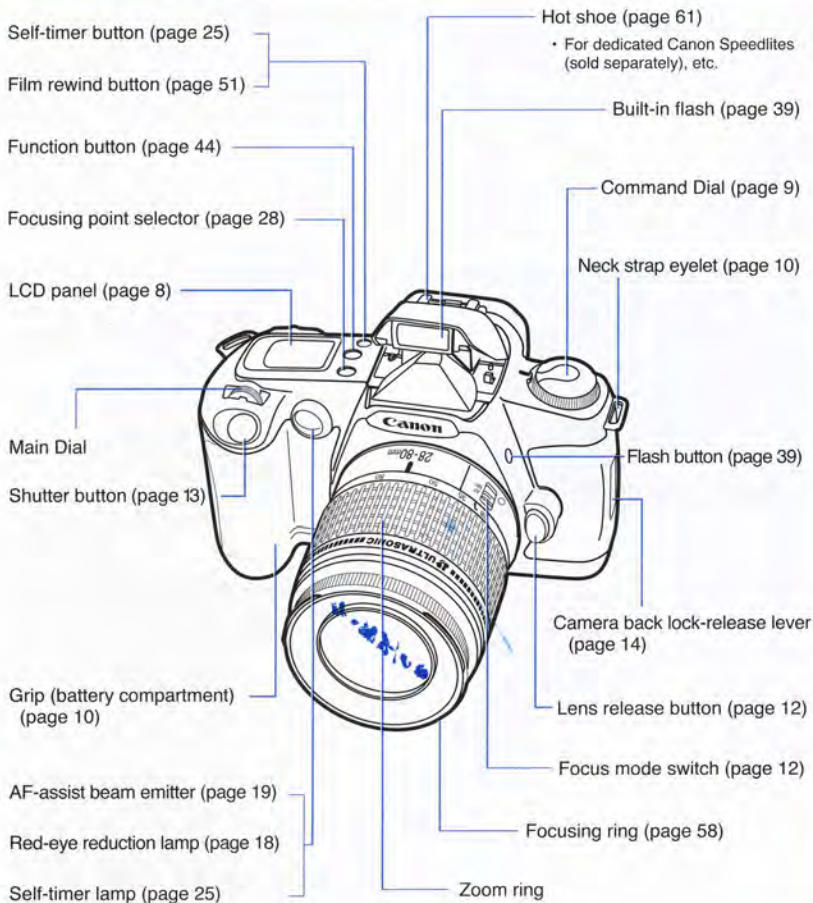

*For details, see the page number in parentheses.
www.bakkas.us

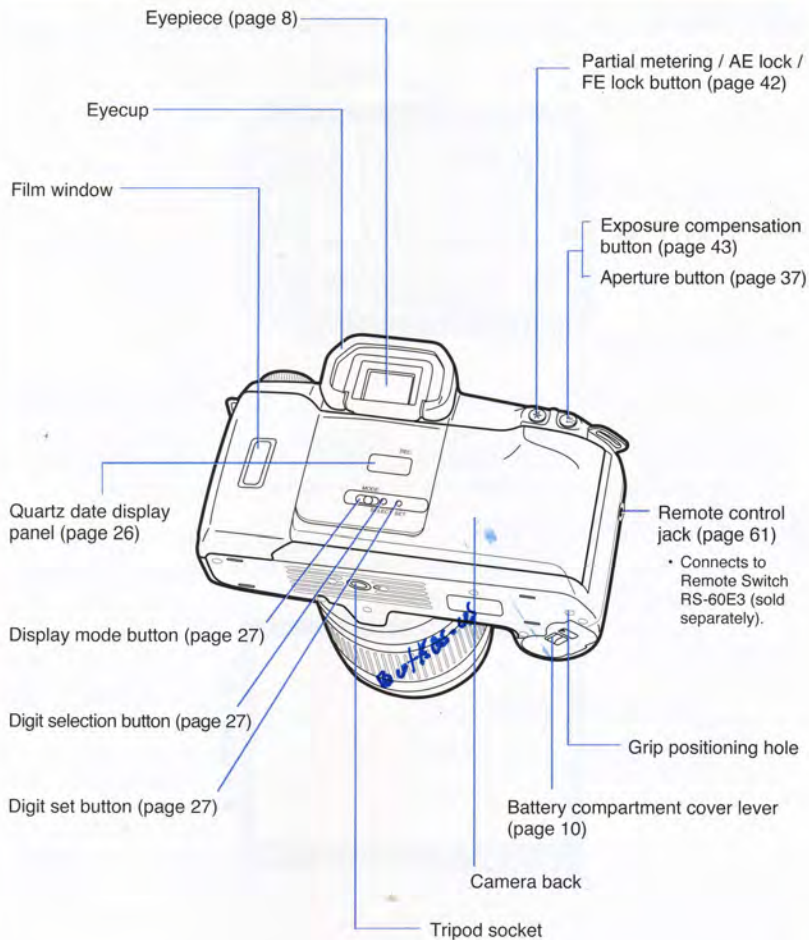

LCD Panel

The LCD panel is shown with all the information displayed.

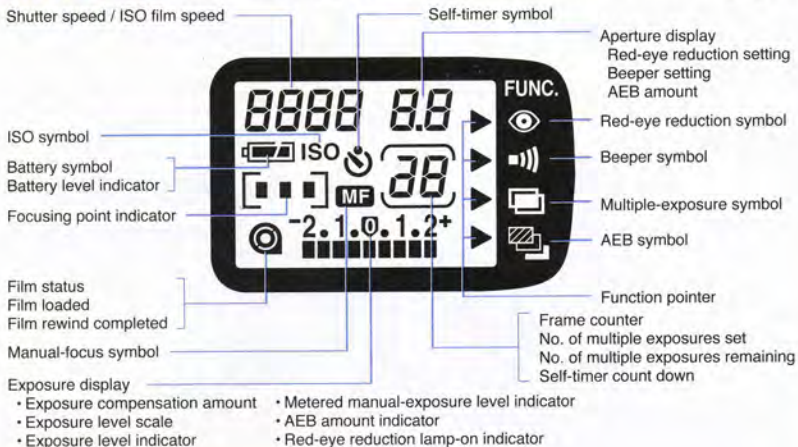

Viewfinder Information

The viewfinder is shown with all the information displayed.

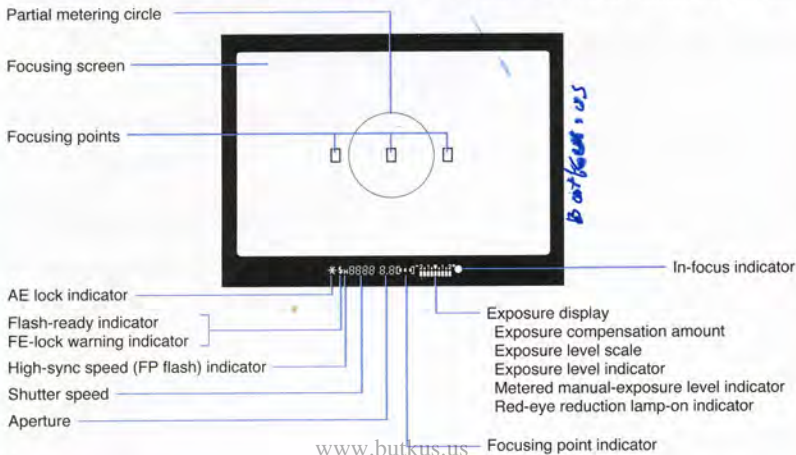

Command Dial

The Command Dial cannot be rotated to where there is no symbol on the dial.

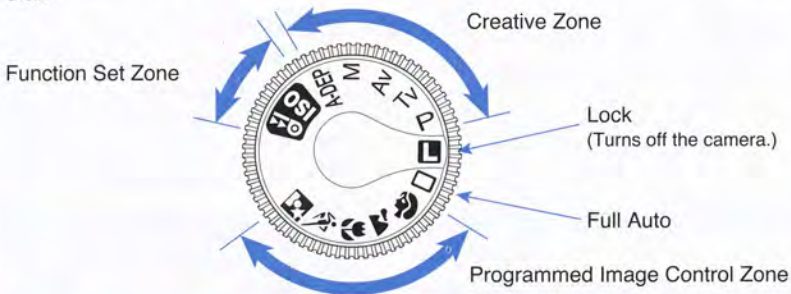





□ : Full Auto (page 16)

The camera takes care of everything. Just aim and press the shutter button.

Programmed Image Control Zone

Fully automatic operation can be set to suit the type of subject.

-  : Portrait (page 20)
-  : Landscape (page 21)
-  : Close-up (page 22)
-  : Sports (page 23)
-  : Night Scene (page 24)

⏏ : Lock

Set to this position when the camera is not to be used. This turns off the camera.

Creative Zone

Allows you to create your own photographic effects.

- P** : Program AE (page 31)
- Tv** : Shutter speed-priority AE (page 33)
- Av** : Aperture-priority AE (page 35)
- M** : Manual exposure (page 37)
- A-DEP** : Depth-of-field AE (page 38)

Function Set Zone

- ISO** : To set the ISO film speed manually. (page 49)
-  : For midroll film rewind. (page 51)

*For details, see the page number in parentheses.



When the camera is not to be used, set the Command Dial to **⏏**. This will prevent accidental battery drainage if the shutter button is held down inadvertently.

I. Before You Start

To have your camera ready for picture-taking, follow the procedures below.

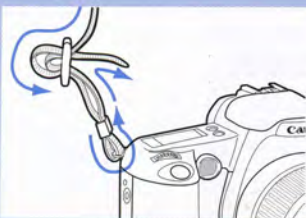

Attaching the neck strap

Pass the end of the strap through the clasp on the inner side. Pull the strap to make sure it does not slip out of the clasp.

Installing the Batteries and Checking the Battery Level

Installing the Batteries

Use DL123A (or CR123A) lithium batteries.

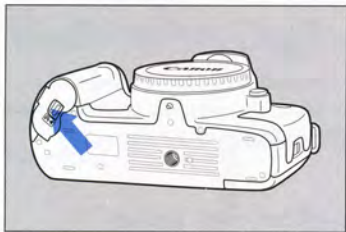

- 1 Slide the battery compartment cover lever as shown by the arrow and open the battery compartment cover.

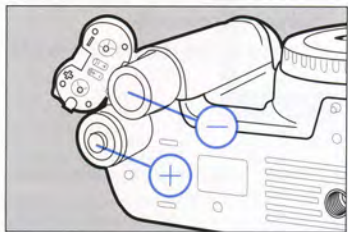

- 2 Insert the batteries with the contacts oriented as shown on the battery compartment cover.
- 3 Close the battery compartment cover.

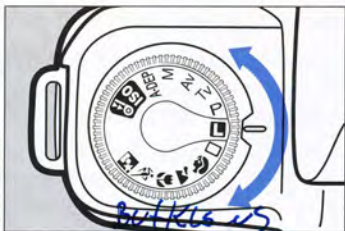

Checking the Battery Level

1 Turn the Command Dial to a Programmed Image Control mode or Creative Zone mode.



2 The battery level will be displayed on the LCD panel by one of the following battery level indicator symbols:

- : Battery level OK.
- : Keep spare battery handy.
- : Replace the battery.

: See page 63.
 • The battery level can be checked when the Command Dial is unlocked.

● DL123A (or CR123A) Lithium Battery Service Life

Ambient Temperature	0% Flash Use	50% Flash Use	100% Flash Use
At 20°C	85 rolls	35 rolls	17 rolls
At -10°C	60 rolls	25 rolls	12 rolls

- * No. of 24-exposure rolls based on Canon's Standard Test Method with new batteries.
- * Operating the camera without film will still consume battery power and reduce the number of rolls that can be taken with the batteries.



- If nothing is displayed on the LCD panel, the batteries may have been installed incorrectly. Take out the batteries and install correctly.



- Before using the camera, be sure to check the battery level.
- In areas where DL123A (or CR123A) batteries may not be easily available, take spare batteries with you.

Mounting and Detaching a Lens

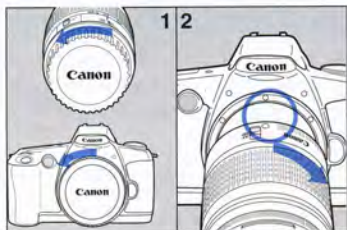

Mounting a Lens

- 1 Remove the rear lens cap and the camera body cap by turning the cap as shown by the arrow.
- 2 Align the red dots on the lens and camera and turn the lens as shown by the arrow until it snaps in place.

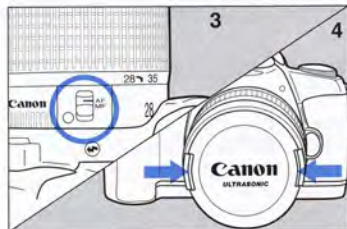

- 3 On the lens, set the focus mode switch to AF.
 - If the focus mode switch is set to MF (or M on some lenses), autofocus will not operate.
 - While the lens autofocuses, do not touch the rotating part of the lens.
- 4 Remove the front lens cap.

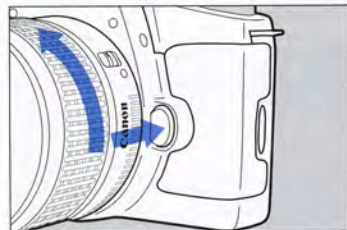

Detaching the Lens

While pressing the lens release button, turn the lens as shown by the arrow until it stops, then remove the lens.

Shutter Button and Autofocusing Operations

The EOS camera's shutter button can be depressed halfway or all the way. It operates as described below (with autofocus enabled).

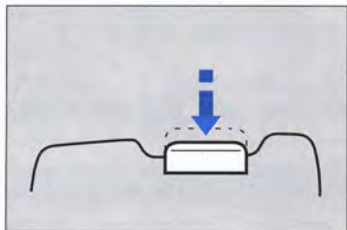

When it is pressed halfway:

- Autofocusing is activated, and when the subject is focused, the camera beeps and the in-focus indicator in the viewfinder lights in green. At the same time, the focusing point indicator for the active focusing point is displayed.
- The shutter speed and aperture are also set and displayed on the LCD panel and in the viewfinder.

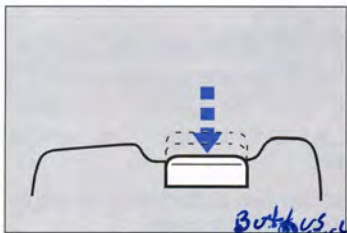

When it is pressed completely:

- The shutter is released to take the picture and then the film advances by one frame.



Camera movement during the moment of exposure is called camera shake. Camera shake can cause blurred pictures.

To prevent blurred pictures due to camera shake:

- Hold the camera steady.
- First press the shutter button halfway, then press all the way.
- Use a faster shutter speed.

Loading and Unloading Film

Loading Film

When a roll of film is loaded, the camera first winds the whole roll onto the camera's spool. Then each time a picture is taken and the frame advances, one frame of film is rewound back into the film cartridge.

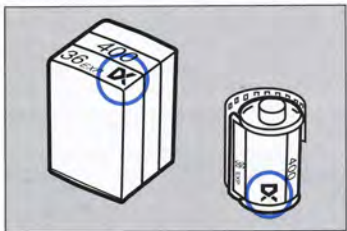

With DX-coded film, the camera automatically sets the film's ISO speed.

- If the film is not DX-coded, set the ISO speed manually. See "Setting the ISO Speed" on page 49.

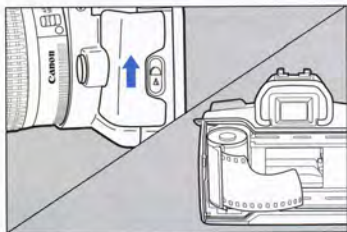

- 1 Unlock the Command Dial.
- 2 Slide down the camera back lock-release lever to open the camera back.
- 3 Insert the film cartridge at an angle as shown in the figure.

Infrared film cannot be used with this camera.

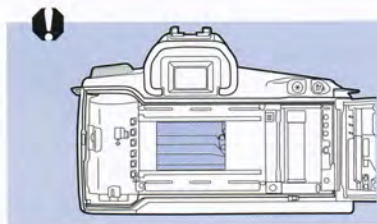

The shutter curtain is manufactured with very high precision. To prevent damage, never touch the shutter curtain. When loading or unloading film, be careful not to touch the shutter curtain with your fingers or the film.

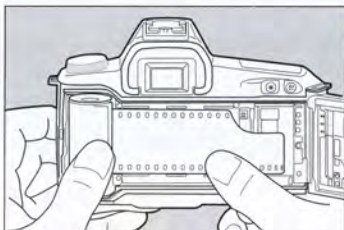

- 4** Hold down the film cartridge and pull the edge of the film leader to the orange mark on the camera.

- If the edge of the film leader goes beyond the orange mark, rewind some of the film back into the cartridge.

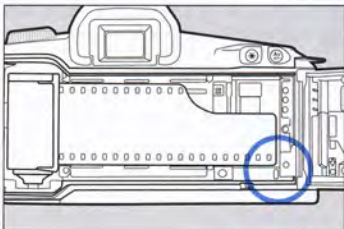

- 5** After checking that the film leader edge is correctly aligned with the orange mark, close the camera back. The film will then wind on the spool and the frame counter will count up. The camera will then make a shutter release sound and the film symbol (📷) will be displayed.

- While the film is being wound, the ISO film speed will be displayed on the LCD panel.
- If the film has not been loaded properly, the frame count will not be displayed and the film symbol will blink. Load the film again.



Unloading Film

After the film's last frame is exposed, the camera rewinds the film automatically. When the film rewind ends, only the film symbol will blink on the LCD panel.

Check that the film symbol is blinking, then open the camera back and unload the film.

- The film symbol will blink for 3 seconds, then it will stay on.

II. Basic Operation

Easy picture-taking with the Command Dial's Full Auto and Programmed Image Control modes is described here. With these fully-automatic picture-taking modes, all you do is press the shutter button and the camera does the rest.

The Full Auto mode and Programmed Image Control modes override all camera controls except the shutter button.

□ Full Auto Mode

The Full Auto mode is for any type of subject. You only need to press the shutter button. One of the three focusing points is used to focus the subject for easy picture-taking.

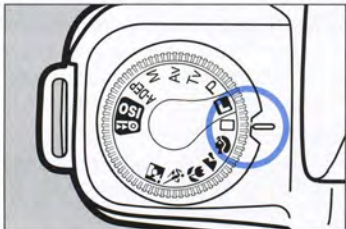

- 1 Turn the Command Dial to □.



- 2 Look through the viewfinder and aim one of the three focusing points on the subject.
 - The camera will select a focusing point to focus what it perceives as the subject.
 - If none of the focusing points cover the subject, see "Focus Lock" on page 30.

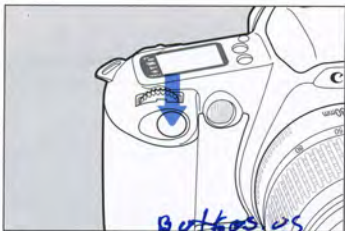

- 3** Press the shutter button halfway. The subject will be focused and the shutter speed and aperture will be set automatically.

- When focus is achieved, the green in-focus indicator lights.
- The active focusing point will light on the LCD panel and in the viewfinder.
- The shutter speed and aperture will be displayed on the LCD panel and in the viewfinder.
- In low-light or backlit conditions, the built-in flash fires automatically.

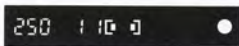





- 4** Press the shutter button completely to take the picture.



- In-focus indicator warning
If the in-focus indicator blinks, the shutter cannot be released. See page 58.
- Display of the multiple focusing points
When focus is achieved, more than one focusing point indicator at the bottom of the viewfinder may light. This indicates that those corresponding focusing points have achieved focus.
- How the focusing point is selected automatically
As a general principle, the focusing point covering the closest, focusable object is selected automatically.

Automatic Flash Operation

In the Full Auto mode  or in the , , and  Programmed Image Control modes, the built-in flash pops up and fires automatically for dark or backlit (fill-in flash) subjects.



If the built-in flash is obstructed from popping up automatically, the battery level indicator on the LCD panel will blink for 3 seconds and then remain displayed as a warning. If this happens, press the shutter button halfway to cancel the warning.



If you do not want to use flash, use the **P** (Program AE) mode. See page 31.



The Red-Eye Effect

When flash is used in low-light situations, it may reflect off the subject's pupils and make the eyes look red in the photograph.

Setting Red-Eye Reduction

The red-eye reduction feature helps reduce red eye with the camera's red-eye reduction lamp which gently shines into the subject's eyes to decrease the pupil diameter, thereby reducing the chances of red eye from occurring. Red-eye reduction can be set in any picture-taking mode.



- 1** Press the function button until the function pointer points to the red-eye reduction symbol () on the LCD panel.
- 2** Turn the Main Dial as shown by the arrow so that "1" appears on the LCD panel.
 - To disable red-eye reduction, turn the Main Dial in the opposite direction to set it to "0".
 - The function pointer  will disappear and the red-eye reduction feature will be disabled.
- 3** The setting will take effect 6 seconds later or when the Main Dial is turned.



- The red-eye reduction lamp lights after the shutter button is pressed halfway and focus has been achieved.
- The red-eye reduction lamp will light again if the shutter button is pressed halfway again.
- While the red-eye reduction lamp is lit, the red-eye reduction lamp-on indicator in the viewfinder will gradually fade.



- Red-eye reduction may be effective only when the subject looks at the red-eye reduction lamp. The actual effectiveness will depend on the subject.
- To increase the effectiveness of red-eye reduction, take the picture after the red-eye reduction lamp-on indicator in the viewfinder turns off.
- The picture can be taken at anytime even while the red-eye reduction lamp is lit. Just press the shutter button completely.

AF-Assist Beam

Under difficult autofocusing conditions, the AF-assist beam is emitted automatically to assist autofocus.

- The AF-assist beam can be activated in any Programmed Image Control mode and Creative Zone mode.
- If Speedlite 540EZ is used with the camera, the AF-assist beam will be emitted by the Speedlite instead. With any other external, EOS-dedicated Speedlite, the AF-assist beam will be emitted by the camera. However, if the center focusing point has been selected manually in a Creative Zone mode, the AF-assist beam will be emitted by the EOS-dedicated Speedlite instead of the camera.



Single-frame and continuous shooting

- When the shutter button is held down completely, the shooting mode (single-frame or continuous) is set automatically by the current picture-taking mode. Refer to page 65 to see which shooting mode is set.

Portrait Mode



This mode blurs the background to make the human subject stand out.

- Holding down the shutter button enables continuous shooting.
- For dark or backlit (fill-in flash) subjects, the built-in flash pops up and fires automatically.

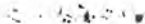

Set the Command Dial to .

- The picture-taking procedure is the same as for the Full Auto mode (page 16).

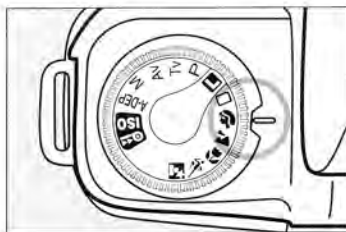

- Head-and-shoulder shots result in the best background blur effect. Also, the further away the subject is from the background, the more blurred the background will become.
- Using a telephoto lens also blurs the background further. If a zoom lens is used, use the longest focal length. (For example, a 28-80mm zoom lens set to 80 mm.)

Landscape Mode



This is for sweeping scenery, sunsets, etc.

- The built-in flash does not operate in this mode.

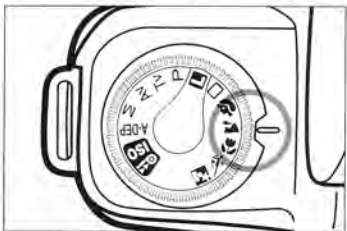

Set the Command Dial to .

- The picture-taking procedure is the same as for the Full Auto mode (page 16).



- If a zoom lens is attached, use the shortest focal length. (For example, a 28-80mm zoom lens set to 28 mm.) The resulting photograph will have more depth from the foreground to the background and a wider breadth.



- If the shutter speed display blinks, the shutter speed may be too slow to prevent a blurred picture due to camera shake. Hold the camera steady or use a tripod. (The shutter speed will still blink even while a tripod is used.)

Close-up Mode



Set this mode when using the lens' built-in macro feature for taking close-up shots of flowers, insects, etc.

- For dark or backlit (fill-in flash) subjects, the built-in flash pops up and fires automatically.

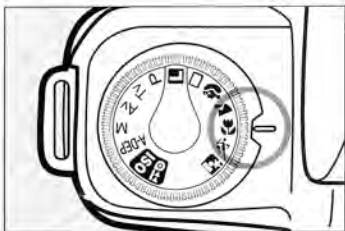

Set the Command Dial to .

- The picture-taking procedure is the same as for the Full Auto mode (page 16).



- Focus the subject at the lens' minimum focusing distance.
- If a zoom lens is used, use the longest focal length to obtain a larger magnification.
- For better close-ups, an EF macro lens and Macro Ring Lite ML-3 (both sold separately) are recommended.

Sports Mode



This mode is ideal for sports photography and capturing fast-moving subjects.

- Holding down the shutter button enables continuous shooting.
- The built-in flash does not operate in this mode.

Set the Command Dial to .

- The picture-taking procedure is the same as for the Full Auto mode (page 16).

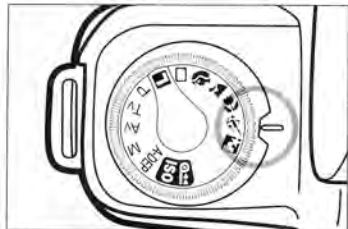

- Using ISO 400 or faster film is recommended.
- For sports photography, a telephoto lens such as the EF 80-200mm f/4.5-5.6 USM or EF 75-300mm f/4-5.6 is recommended.



If the shutter speed display blinks, the shutter speed may be too slow to prevent a blurred picture due to camera shake. Hold the camera steady or use a tripod. (The shutter speed will still blink even while a tripod is used.)

Night Scene Mode



Use this mode when taking a photo of a human subject at sunset or at night.

Flash is used to illuminate the subject and a slow shutter speed is used to expose the background, resulting in a natural-looking exposure.

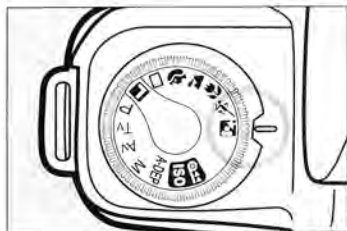

Set the Command Dial to .



- Using ISO 400 or faster film is recommended.
- When using this mode, use a tripod to prevent camera shake.
- For scenery only (no human subjects), use the Landscape mode .
- The Night Scene mode uses a slow shutter speed. Tell the subject not to move immediately after the flash fires.
- If the self-timer is used, the red-eye reduction lamp will flash after the exposure is completed.
- An external EOS-dedicated Speedlite will also work with this mode.
- If the Night Scene mode is used in daylight, it will be the same as the Full Auto mode.

III. Self-Timer and Quartz Date (QD model only)



The camera has a self-timer, and QD models have a quartz date feature to imprint the date or time.

Self-timer Operation

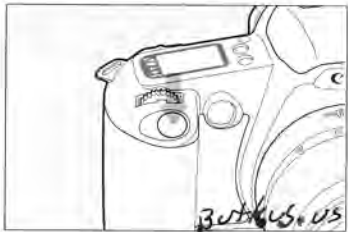
The self-timer can be used in any picture-taking mode. Using a tripod is recommended.



- If you start the self-timer while standing in front of the camera, the focus may be incorrect.
- To cancel the self-timer, press the self-timer button again.
- When using the self-timer to take a picture of only yourself, first lock the focus (see page 30) on an object near where you will be in the picture.

- 1 Press the self-timer button.
 - The  symbol will be displayed on the LCD panel.
 - To cancel the self-timer, press the self-timer button again or turn the Command Dial to .

- 2 Press the shutter button halfway to focus, and check the shutter speed and aperture setting.

- 3 While still looking through the viewfinder, press the shutter button completely to start the self-timer. The beeper will sound and the shutter will be released after 10 sec.

The beeper beeps slowly (twice/sec.) during the first 8 seconds and faster (8 times/sec.) during the final two seconds before the shutter is released.

- The self-timer display on the LCD panel counts down in seconds.
- The camera's red-eye reduction lamp lights two seconds before the shutter is released.

Imprinting the Date or Time (QD model only)

QD models have a quartz date feature which maintains an automatic calendar to the year 2019. It can imprint the date or time on the photographs you take. The year, month, and day are initially displayed on the quartz date display panel. If left unchanged, the date in this format will be imprinted on the photograph at the same time the photograph is taken. The date or time can be imprinted in any picture-taking mode.

Pressing the MODE button changes the date/time format to be imprinted, in the sequence shown on the display panel as follows:

Year, month, day 99 10 20 (1996 Oct. 20)



Day, hour, minute 20 16 45 (20th 16:45)



Hyphens - (Blank)



Month, day, year 10 20 96 (Oct. 20, 1996)



Day, month, year 20 10 96 (20 Oct. 1996)

- "M" is displayed above the month.
- When the picture is taken, "-" blinks to indicate that the date or time has been imprinted



Disabling Date or Time Imprinting

If you do not want to imprint the date or time on the photograph, press the MODE button until the LCD panel displays " - - - - -".

- The date or time is imprinted as shown in the above photograph. The actual imprinted date or time does not have the "M" or "-" displayed on the display panel.

Setting the Date and Time

To set or change the date and time, follow the procedure below:

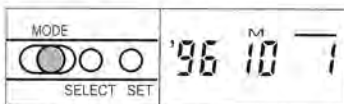

- 1 Press the MODE button to display the date or time to be set.



- 2 Press the SELECT button so that the digit to be changed blinks.



- 3 Keep pressing the SET button until the correct number appears.



- 4 Press the SELECT button until none of the digits blink. This sets the new date or time.

Replacing the Quartz Date Battery

When the quartz date display panel looks faded, replace the CR2025 lithium battery as follows. Battery life is about 3 years.



- 1 Open the camera back and loosen the screw to remove the battery compartment cover as shown in the figure.

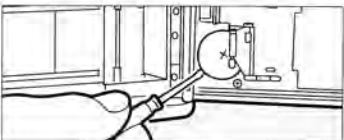

- 2 Take out the battery.
- 3 Insert a new battery with the positive contact facing you. Then reattach the battery compartment cover.
- 4 Close the camera back and set the correct date and time.

IV. Advanced Operations

The Creative Zone modes make picture-taking more flexible with shutter speed-priority and aperture-priority modes, user-selected focusing points, and options for changing the exposure settings. The Creative Zone modes are described here along with other advanced operations.

Focusing Point Selection

The focusing points are the little boxes which focus the subject. The focusing point can be selected automatically by the camera or manually by you.

In the Full Auto, A-DEP, and all Programmed Image Control modes, the focusing point can only be selected automatically. In the **P**, **Tv**, **Av**, and **M** modes, the focusing point can be selected either automatically or manually.

Automatic selection: The camera selects the focusing point automatically depending on the scene. Ideal for snapshots.

Manual selection: You can select any focusing point to focus the subject. This ensures that the camera focuses the subject you want. It is also effective for focusing off-center subjects quickly.

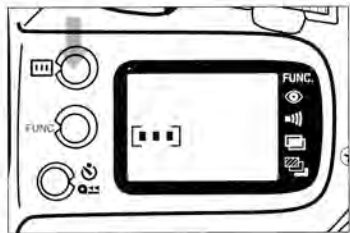

Selecting the focusing point automatically or manually

- 1 Set the Command Dial to the **P**, **Tv**, **Av**, or **M** mode.
- 2 Press the focusing point selector.
 - The focusing point indicator for the current focusing point is displayed.
 - The focusing point indicator remains displayed for 6 seconds after the focusing point selector is released.

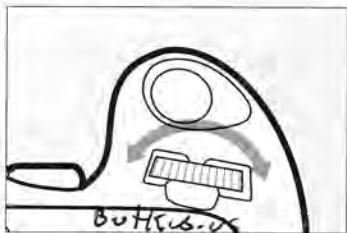

- 3 Look at the focusing point indicator on the LCD panel or in the viewfinder and turn the Main Dial until the desired focusing point indicator is displayed.

: Sets the focusing point selection to automatic.

: Selects the left focusing point.

: Selects the center focusing point.

: Selects the right focusing point.

- The focusing point indicator changes in the above looping sequence as the Main Dial is turned.

- 4 Press the shutter button halfway to register the focusing point selection.

- If the shutter button is not pressed halfway within 6 seconds, the focusing point selection will be registered automatically.



If you select the focusing point manually and then you set the Command Dial to Full Auto or a Programmed Image Control mode, your focusing point selection will be overridden and automatic focusing point selection will take effect.

Focusing an Off-Center Subject

If you want to focus an off-center subject not covered by any of the focusing points, following the procedure below.



- 1 Aim the manually-selected focusing point on the subject, then press the shutter button halfway to focus.



- 2 Keep pressing the shutter button halfway and recompose the picture.

- 3 Press the shutter button completely to take the picture.

P Program AE



Like the Full Auto mode (□), this is a general-purpose picture-taking mode. The camera automatically sets the shutter speed and aperture to suit the scene's brightness.

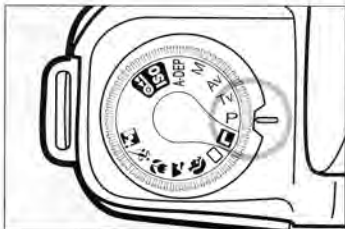

1 Set the Command Dial to P.

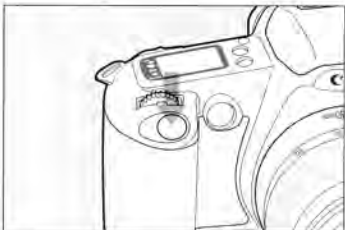

2 Press the shutter button halfway to focus the subject.

- The shutter speed and aperture will be displayed in the viewfinder and on the LCD panel display.
- After the shutter button is pressed halfway and released, the shutter speed and aperture will remain displayed for about 4 seconds.



3 Check the shutter speed and aperture, then press the shutter button completely to take the picture.



In a Creative Zone mode, the LCD panel and viewfinder will show the exposure level scale and exposure level indicator in addition to the shutter speed and aperture. The exposure level indicator indicates the exposure compensation amount and exposure level in the manual exposure mode.



Difference Between Program AE Mode and Full Auto Mode

The Program AE (P) mode and Full Auto (□) mode obtain the same shutter speed and aperture settings for picture-taking. However, the Program AE mode is more flexible by allowing you to override the camera settings and use the features below.

☉: Settable by the user. ×: Not settable by the user.

Feature	P	Full Auto
Continuous shooting	☉	×
Program shift	☉	×
Exposure compensation	☉	×
Autoexposure bracketing	☉	×
Partial metering/AE lock	☉	×
Manual focusing point selection	☉	×
Manual firing of built-in flash	☉	×
High-speed sync with EX-series Speedlite	☉	×
FE lock with EX-series Speedlite	☉	×

Shifting the Program

In the Program AE mode, you can freely change the shutter speed and aperture combination (program) set by the camera while maintaining the same exposure value. This is called shifting the program.

To shift the program, press the shutter button halfway and turn the Main Dial until the desired shutter speed or aperture is displayed.

- After the picture is taken with the shifted program, the shifted program is canceled automatically and the original program is restored.
- If the built-in flash is used, the program cannot be shifted.
- The program can be shifted only to a shutter speed from 30 to 1/2000 sec. and within the minimum and maximum aperture settings of the lens.

Tv Shutter-Speed Priority AE



Taken at a fast shutter speed



Taken at a slow shutter speed

In this mode, you set the shutter speed and the camera sets the aperture automatically to suit the brightness of the scene. (Tv stands for Time value.) By setting a fast shutter speed, you can freeze the motion of a fast-moving subject. And by setting a slow shutter speed, you can blur the subject to give the impression of motion.



To photograph a scene on a TV screen, use a shutter speed of 1/15 sec. for best results. Use a tripod to prevent blur.



- 1 Set the Command Dial to **Tv**.



- 2 Turn the Main Dial until the desired shutter speed is displayed.



3 Press the shutter button halfway to focus the subject.

- The shutter speed and aperture will be displayed in the viewfinder and on the LCD panel.



4 Check the aperture and take the picture.



- If the maximum aperture (the smallest f-number) blinks, the scene is too dark. In such a case, turn the Main Dial to set a slower shutter speed until the aperture stops blinking.



- If the minimum aperture (the largest f-number) blinks, the scene is too bright. In such a case, turn the Main Dial to set a faster shutter speed until the aperture stops blinking.



Shutter Speed Display

The shutter speed can be set and displayed in full and half steps as shown below. Shutter speeds from 2 to 2000 indicate the denominator of the fractional shutter speed. For example, 125 is 1/125 second. For slower shutter speeds, the numeral is appended with the seconds mark ("). For example, 0"7 is 0.7 second and 15" is 15 seconds.

30"	20"	15"	10"	8"	6"	4"	3"	2"	1"5	1"	0"7									
2	3	4	6	8	10	15	20	30	45	60	90	125	180	250	350	500	750	1000	1500	2000

Av Aperture-Priority AE



Taken with a large aperture



Taken with a small aperture

In this mode, you set the aperture and the camera sets the shutter speed automatically to suit the brightness of the scene. (Av stands for aperture value.)

By setting a larger aperture (smaller f-number), you can blur the background and make the subject stand out.

Or, by setting a smaller aperture (larger f-number), you can increase the depth of field to make both the foreground and background look sharp.

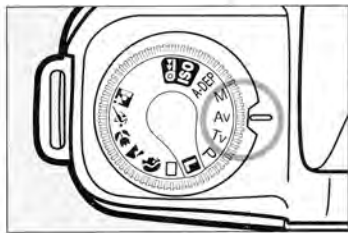

- 1 Set the Command Dial to **Av**.



- 2 Turn the Main Dial until the desired aperture is displayed.

IV. Advanced Operations

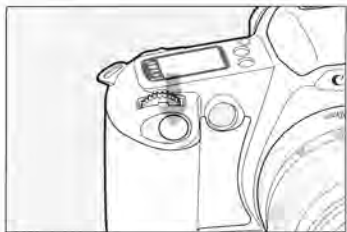

3 Press the shutter button halfway to focus the subject.

- The shutter speed and aperture will be displayed in the viewfinder and on the LCD panel.

125 4.0C • 1^{-2.1} 1.2*



4 Check the shutter speed and take the picture.



- If the 30" shutter speed blinks, the scene is too dark. In such a case, turn the Main Dial to set a larger aperture (smaller f-number) until the shutter speed stops blinking.



- If the 2000 shutter speed blinks, the scene is too bright. In such a case, turn the Main Dial to set a smaller aperture (a larger f-number) until the shutter speed stops blinking.



Aperture Display

The aperture can be set and displayed in full and half stops as shown below. The higher the aperture setting (f-number), the smaller the aperture opening will be. The displayable range of aperture settings depends on the lens mounted on the camera. When no lens is mounted on the camera, "00" is displayed for the aperture setting.

1.0 1.2 1.4 1.8 2.0 2.5 2.8 3.5 4.0 4.5 5.6 6.7 8.0 9.5
11 13 16 19 22 27 32 38 45 54 64

M Manual Exposure

In this mode, you set the shutter speed and the aperture for total exposure control. The exposure level of the shutter speed and aperture combination you set is indicated on the exposure level scale so you can see whether the exposure is suitable.

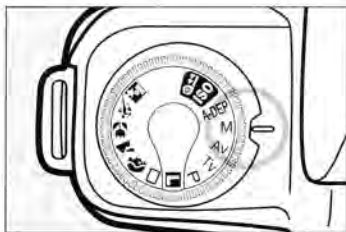

- 1 Set the Command Dial to **M**.
- 2 Turn the Main Dial to set the shutter speed.

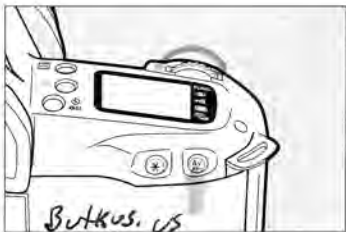

- 3 Press and hold down the aperture button and turn the Main Dial to set the desired aperture.
- 4 Press the shutter button halfway to focus the subject.

- Check the exposure level indicator in the viewfinder or on the LCD panel.

Indicates a correct exposure	-2.1.0.1.2+
Indicates overexposure	-2.1.0.1.2+
Indicates underexposure	-2.1.0.1.2+

- 5 Look at the exposure level indicator and adjust the exposure level if necessary.

Correct exposure: This is the standard reference point for a correct exposure.

Overexposure: To achieve the correct exposure, increase the shutter speed or set a smaller aperture.

Underexposure: To achieve the correct exposure, decrease the shutter speed or set a larger aperture.

- 6 Take the picture.

A-DEP Automatic Depth-of-Field AE

This mode is for obtaining a wide depth of field automatically between a near subject and far subject. It is effective for large-group photos and landscapes.

The camera uses the three focusing points to detect the nearest subject and the farthest subject.

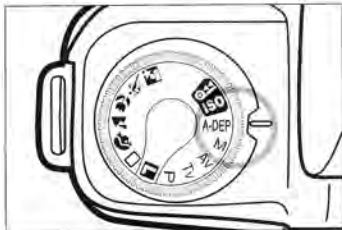

1 Set the Command Dial to **A-DEP** and make sure the focus mode switch on the lens is set to AF.

2 Press the shutter button halfway to focus the subject.

- The active focusing points, the shutter speed, and aperture are displayed in the viewfinder and on the LCD panel. The area between the nearest subject covered by a focusing point and the furthest subject covered by another focusing point will be in sharp focus.

3 Check the shutter speed and aperture and take the picture.



In this example, the focus will be sharp from the right subject covered by the right focusing point up to the left subject covered by the left focusing point.



- If the aperture blinks, it indicates that the exposure level is correct but the desired depth of field cannot be achieved. Either use a wide-angle lens or move further away from the subjects.
- You cannot freely change the shutter speed and aperture. If the camera sets a slow shutter speed, hold the camera steady or use a tripod.
- Automatic depth-of-field AE cannot be used if the lens' focus mode switch is set to MF (or M on some lenses).

7 Using the Built-in Flash

In Creative Zone modes, flash photography is possible at any time regardless of the ambient light level. Whether the built-in flash or an external EOS-dedicated Speedlite is used, the basic operation is the same as with an AE mode.

When flash is used in a Creative Zone mode, the shutter speed (the maximum sync speed or slower) and/or the aperture can be set as usual. The flash output is controlled automatically to match the set aperture. Since the 3-zone TTL autoflash system is linked to the active focusing point, the flash exposure is weighted on the subject in focus.

- For automatic flash photography, set the Command Dial to P.
The shutter speed and aperture will be set automatically as with the Full Auto mode. The flash exposure will be weighted on the subject that is in focus.
- To set the flash aperture manually, set the Command Dial to Av.
In low-light conditions, a slow sync speed will be set automatically to obtain a suitable exposure of the subject and background. For the subject, the flash output is set automatically to match the set aperture for a proper exposure. For the background, the sync speed is set automatically to obtain a proper exposure.
 - When a slow sync speed is set, using a tripod is recommended.
- To set the sync speed manually, set the Command Dial to Tv.
The flash aperture is set automatically to match the sync speed for a proper exposure, and the flash output is controlled automatically to match the flash aperture.
 - If you set a shutter speed faster than 1/90 sec., the sync speed will be set automatically to 1/90 sec.
- To set both the flash aperture and the sync speed manually, set the Command Dial to M.
For the background, the shutter speed and aperture can be set manually. The flash output is then controlled automatically to match the manually-set flash aperture for a proper exposure.



- If A-DEP is set and flash is used, the result will be the same as using flash in the P (Program AE) mode.

IV. Advanced Operations

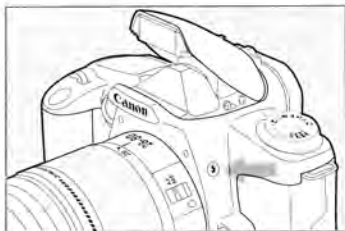

1 Press the flash button to pop up the flash.

- To retract the flash head after use, push it down.

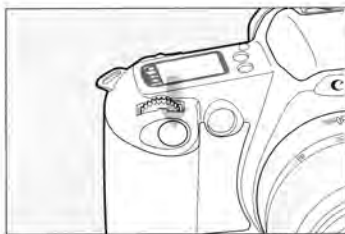

2 Press the shutter button halfway and focus the subject.

3 Check that the lightning symbol in the viewfinder lights, then take the picture.



Setting Red-Eye Reduction

When flash is used in a low-light environment, the subject's eyes may look red in the photograph. This happens when the light from the flash reflects off the pupils of the eyes. To set the camera's red-eye reduction feature, see page 18.

Effective Flash Range

ISO	28 mm		80 mm	
	Negative Film	Reversal Film	Negative Film	Reversal Film
100	1 - 4.8 m	1 - 3.4 m	1 - 3 m	1 - 2.1 m
400	1.2 - 9.6 m	1.5 - 6.8 m	1 - 6 m	1.5 - 4.3 m

Flash Exposure Warnings

Mode	Warnings	Description	Remarks
Tv (Shutter speed-priority AE)	The lens' maximum aperture blinks.	Background overexposure warning.	The subject will be correctly exposed.
	The lens' minimum aperture blinks.	Background underexposure warning.	
Av (Aperture-priority AE)	The 1/90 sec. shutter speed blinks.	Overexposure warning.	The subject will be correctly exposed. If the aperture is changed, the shutter speed may change.
	The 30" shutter speed blinks.	Underexposure warning.	



- When using the built-in flash, keep at least 1 meter away from the subject. Otherwise, part of the photo will look dark because the lens barrel will partially obstruct the flash coverage.
- When using the built-in flash, detach any hood attached to the lens. A lens hood will partially obstruct the flash coverage.
- Using the built-in flash with any of the following lenses may partially obstruct the flash coverage. Use an external flash unit instead.
 - EF 17-35mm f/2.8L USM, EF 28-70mm f/2.8L USM, and other large-aperture lenses.
 - EF 300mm f/2.8L USM, EF 600mm f/4L USM, and other super telephoto lenses.
- The built-in flash cannot be used together with an external flash unit.
- If an EOS-dedicated Speedlite, etc., is attached to the hot shoe, the built-in flash will not operate.
- Before attaching an EOS-dedicated Speedlite, etc., retract the built-in flash.

Partial Metering and AE Lock

In high-contrast situations such as a person spotlighted against a dark background, the exposure may turn out too bright or too dark in certain areas of the photograph. To obtain a more accurate exposure in such cases, use AE lock to lock the subject's exposure level.



Partial metering circle

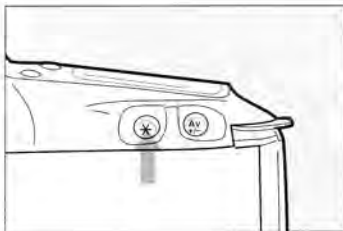

1 Set the Command Dial to a Creative Zone mode.

2 Aim the active focusing point where you want to lock the exposure, then press the shutter button halfway to achieve focus.

- The exposure setting (shutter speed and aperture) will be displayed in the viewfinder and on the LCD panel.

3 If necessary, move the partial metering circle over the area where you want to lock the exposure, then press the AE lock button (*).

- The AE lock indicator (*) in the viewfinder lights and the exposure level locks. The exposure level will be locked for about 4 seconds after the AE lock button is released.
- Whenever the AE lock button is pressed, it locks the exposure level for the area currently covered by the partial metering circle.
- AE lock will be canceled 4 seconds after the AE lock button is released or if the Command Dial is turned.
- If the Command Dial is set to **M** (see page 37), the exposure level indicator will indicate the difference between the exposure setting you have set and the partial metering exposure level of the subject.

4 Recompose the shot, focus if necessary, then take the picture.

To take continuous shots with AE lock, hold down the AE lock button (*) and press the shutter button.

Exposure Compensation

Changing the exposure level set by the camera is called exposure compensation. Exposure compensation can be used to make the picture darker or brighter intentionally. Exposure compensation can be set up to 2 stops in half steps.



1 Set the Command Dial to a Creative Zone mode except **M**.

2 Press the shutter button halfway and focus the subject.

- The shutter speed and aperture will be displayed in the viewfinder and on the LCD panel.



3 Press and hold down the exposure compensation button and turn the Main Dial until the desired exposure compensation amount is set.

- The plus side of the scale indicates overexposure and the minus side of the scale indicates underexposure.
- To cancel the exposure compensation setting, set the exposure level indicator to 0.

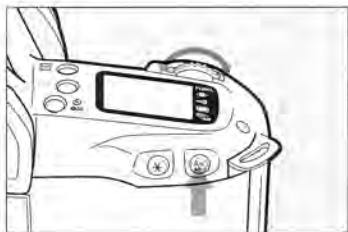

4 Take the picture.



- The exposure compensation setting will be canceled if the Command Dial is set to a Programmed Image Control mode.
- Assuming that a shutter speed of 1/125 sec. and an aperture of f/5.6 will give a correct exposure, setting the exposure compensation amount to plus or minus 1 stop on the exposure level scale will be equivalent to the following settings:

	-1 stop	←	0	→	+1 stop
Shutter Speed	250	←	125	→	60
Aperture	8.0	←	5.6	→	4.0

Autoexposure Bracketing (AEB)

With autoexposure bracketing, the camera automatically changes the exposure level within the set range for three successive frames. The bracketing amount centers on the correct exposure (or the exposure compensation setting), and the exposure can be varied up to 2 stops in half stops. The three bracketed shots are exposed in the following sequence: correct exposure, underexposure, and overexposure. The film advances according to the current picture-taking mode. (See “Feature Availability Table” on page 60.) Bracketing is useful for obtaining the desired exposure or effect, especially with reversal film which has a narrow exposure latitude.



Correct exposure



Underexposure (-0.5 stop)



Overexposure (+0.5 stop)

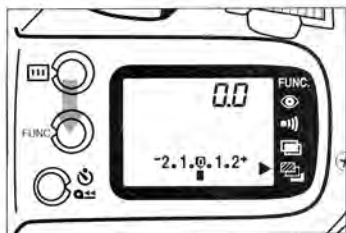

1 Set the Command Dial to a Creative Zone mode.

2 Press the function button until the function setting pointer points to .

3 Turn the Main Dial to set the desired bracketing amount.

- The bracketing amount is displayed on the LCD panel. For example, if it is set to 0.5, the bracketing sequence will be: correct exposure, underexposure by -0.5 stop, and overexposure by +0.5 stop.
- To cancel autoexposure bracketing, set the bracketing amount to 0.0.



-2.1.0.1.2+ • Bracketing amount of
 1 stop

-2.1.0.1.2+ • Bracketing amount of
 -1 stop

-2.1.0.1.2+ • Bracketing amount of
 -1.5 stop

-2.1.0.1.2+ • Bracketing amount of
 -2 stops

If the set bracketing amount exceeds 2 stops, the display will be as shown on the left. Autoexposure bracketing and the bracketing amount will still work properly.

4 Turn the Main Dial or wait for 4 seconds until the bracketing amount takes effect.

5 Take the bracketed shots with the film advance mode set with the current picture-taking mode. See “Feature Availability Table” on page 61.

- The exposure level scale in the viewfinder and on the LCD panel will show the bracketing amount for each bracketed shot.
- The AEB symbol's function setting pointer and dot will blink while the bracketed pictures are taken.

Correct exposure -2.1.0.1.2+

Underexposure -2.1.0.1.2+



Overexposure -2.1.0.1.2+



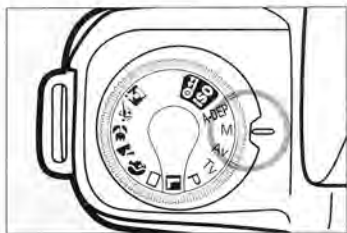

- If the Command Dial is set to a Programmed Image Control mode or if the built-in flash or a Canon Speedlite is used, the autoexposure bracketing setting will be canceled.
- The three bracketed shots can be taken continuously by holding down the shutter button in the continuous shooting mode. However, the bracketed amount for each shot will not be displayed in the viewfinder.
- If the self-timer is used with autoexposure bracketing, the three bracketed shots will be taken continuously 10 sec. after the self-timer is activated.

Bulb Exposure

When bulb is set, you can expose the film for as long as you press the shutter button completely. Bulb exposures are useful when long exposures are required for night scenes, fireworks, etc. Use a tripod when making a bulb exposure. Remote Switch RS-60E3 (sold separately) makes taking bulb exposures easier.

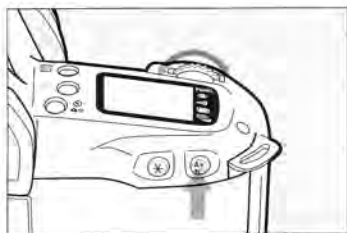

- 1 Set the Command Dial to **M**.
- 2 Turn the Main Dial until **bulb** (which follows 30'') is displayed for the shutter speed.



- 3 Press and hold down the aperture button and turn the Main Dial to set the desired aperture.

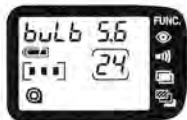

- 4 Frame the shot, then press and hold down the shutter button completely for the duration of the exposure.

- During bulb exposure, **bulb** blinks on the LCD panel.
- With a new set of batteries, a bulb exposure can be as long as about 6 hours.

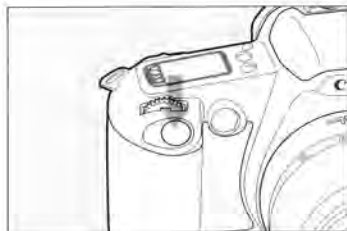

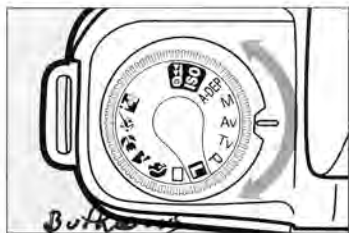

Multiple Exposures

By not advancing the film, a single frame can be exposed multiple times to obtain a special effect.

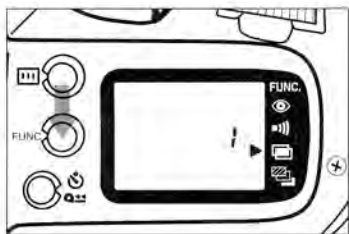

- 1 Set the Command Dial to a Creative Zone mode.



- 2 Press the function button until the function pointer points to the multiple-exposure symbol () on the LCD panel.

- "1" will be displayed on the film counter on the LCD panel.



- 3 Turn the Main Dial to set the desired number of multiple exposures.

- The film counter on the LCD panel will show the number of multiple exposures that is set.
- Up to 9 multiple exposures can be set.
- Press the shutter button halfway or wait 6 seconds for the setting to take effect.
- To cancel the multiple-exposure setting, set the number of multiple exposures to 1.

4 Compose the shot and press the shutter button completely to expose the same frame each time.

- While multiple exposures are taken, the multiple-exposure symbol's function pointer ► blinks on the LCD panel during the 4 seconds while the exposure information is displayed.
- After the set number of multiple exposures are taken, the film advances to the next frame and the multiple exposure setting is canceled.



- When taking multiple exposures on a single frame of film, exposure compensation must be set before the multiple exposures are taken. Also see "Exposure Compensation" on page 43.

As a general guide, you should set the exposure compensation amount shown below for the respective number of multiple exposures.

No. of Multiple Exposures	2	3	4
Underexposure Amount	-1.0 stop	-1.5 stop	-2.0 stops

These are only suggested exposure compensation amounts. The optimum amount depends on the scene. Experiment to discover the optimum compensation amount.

- Turning the Command Dial to a Programmed Image Control mode will cancel the multiple-exposure setting.
- Multiple exposures can be set for bulb exposures.

Setting the ISO Film Speed

If the film is not DX-coded or if you want to set a different ISO film speed, you can set the ISO film speed manually. The ISO film speed can be set from 6 to 6400.

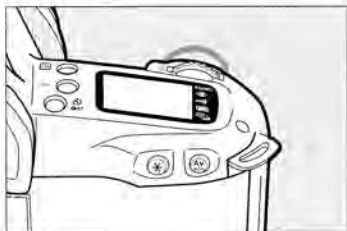
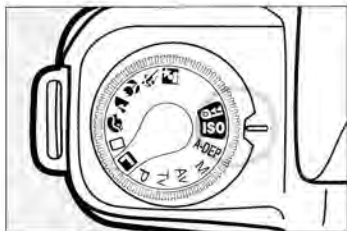

The previously-set ISO film speed will remain effective until another DX-coded film is loaded or until the ISO film speed is changed manually.

1 Turn the Command Dial to **ISO**.

- The **ISO** symbol and the current ISO film speed will be displayed on the LCD panel.





2 Turn the Main Dial until the desired ISO film speed appears on the LCD panel.

3 Turn the Command Dial to the desired mode.

Silencing the In-Focus Beeper

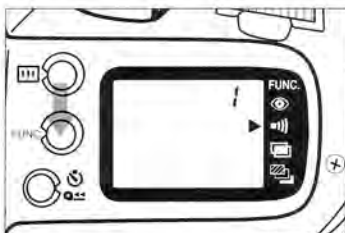
The in-focus beeper can be silenced for all picture-taking modes.



- 1 Press the function button until the function pointer points to the beeper symbol () on the LCD panel.

- The film counter on the LCD panel will show "1".

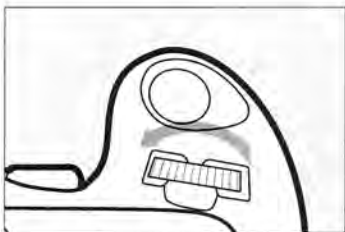

- 2 Turn the Main Dial until the film counter on the LCD panel displays "0".

- The beeper symbol's function pointer on the LCD panel will disappear and the beeper will no longer sound when focus is achieved.
- To activate the in-focus beeper again, set the film counter on the LCD panel to "1" again.

- 3 Turn the Command Dial or wait 6 seconds for the setting to take effect.

Midroll Film Rewind

To rewind and unload the film before reaching the last frame, follow the steps below.



- 1 Set the Command Dial to **M**.

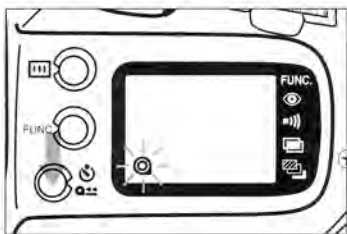

- 2 Press and hold down the film rewind button (self-timer button) for at least 1 second.

- The film will start rewinding. When the film rewind ends, there will be a shutter-release sound and the film symbol (●) on the LCD panel will blink. After about 3 seconds, the film symbol will stop blinking and just stay on.

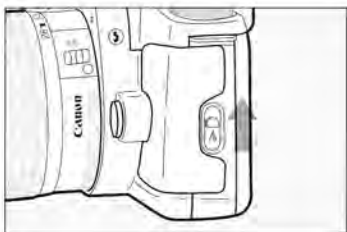

- 3 Open the camera back and remove the film.



If the film is removed from the camera in midroll without being rewound and then a new roll of film is loaded, the new roll (film leader) will only be rewound into the film cartridge. To prevent this, close the camera back and press the shutter button completely before loading a new roll of film.

V. E-TTL Autoflash with an EX-Series Speedlite

With an EX-series Speedlite like the 380EX or 220EX, flash photography is easy with the E-TTL (Evaluative-Through-The-Lens) autoflash system which is linked to the active focusing point. It is as easy as using the built-in flash. An external Speedlite is recommended when a high flash output is required for group shots and special lighting effects.

E-TTL Autoflash System Features

- (1) Since the E-TTL autoflash system (with preflash evaluative metering) is linked to the active focusing point, proper flash exposure is obtained for the subject in focus.
- (2) Even for fill-flash and indoor situations, a natural-looking flash exposure is obtained automatically.
- (3) With the Command Dial set to Av, a slow sync speed is set automatically in low-light situations to obtain a balanced exposure between the subject and background.
- (4) FE (Flash Exposure) lock enables you to lock the correct flash exposure for any part of the picture.
- (5) High-speed sync (FP or Focal-Plane flash) can be used to synchronize the flash with all shutter speeds from 30 sec. to 1/2000 sec.
- (6) In a Creative Zone mode, the aperture and shutter speed (1/90 sec. or slower) can be set manually.
- (7) With multi-flash accessories, multiple Speedlites can be used automatically with the TTL autoflash system which is linked to the active focusing point.



- In the AF mode, the flash output is controlled automatically to match the flash aperture. Since the flash metering is linked to the focusing point, the E-TTL autoflash system weights the flash exposure on the subject in focus.
- When the Speedlite is on in the Full Auto mode or a Programmed Image Control mode, the flash fires each time a picture is taken.
- The camera's red-eye reduction lamp operates even when an external EOS-dedicated Speedlite has been attached to the camera.

www.butkus.us

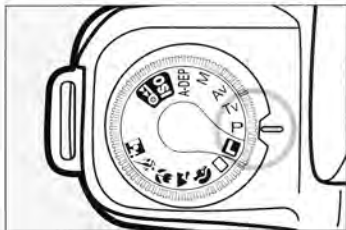

Normal Flash Operation

1 Set the Command Dial to any picture-taking mode except **A-DEP**.

- If A-DEP is set and flash is used, it will be the same as using flash in the **P** (Program AE) mode.



2 Turn on Speedlite 220EX's power switch.

- Make sure the Speedlite's high-speed sync (FP flash) lamp is off. If it is on, press the high-speed sync button to turn off the lamp.

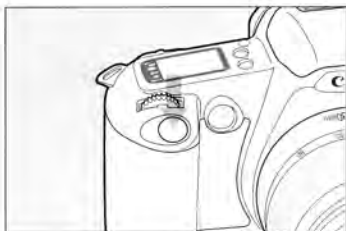

3 Press the shutter button halfway and focus the subject.





4 In the viewfinder, check that the **⚡** symbol, shutter speed, and aperture are displayed.





5 Press the shutter button completely to take the picture.

High-Speed Sync (FP Flash)

With the Speedlite's high-speed sync switch set to , high-speed sync (focal-plane flash) is set automatically when the shutter speed is set faster than 1/90 sec. The Speedlite can then synchronize with all shutter speeds. When high-speed sync is in effect, "H" is displayed on the right of  in the viewfinder.



High-speed sync is effective in the following cases:  

- 1 When you want to use fill-in flash for a portrait and maintain background blur with a large aperture.
- 2 When you want to produce a catchlight in the subject's eyes.
- 3 When you want to use fill-in flash to eliminate shadows



- High-speed sync can be used only in Creative Zone modes. In Programmed Image Control modes, the normal sync speed is set.
- When high-speed sync is used, the Speedlite's Guide No. decreases. If the ambient light is insufficient, using high-speed sync may result in underexposure.

FE Lock

FE (flash exposure) lock obtains and locks the correct flash exposure for the desired portion of the scene.

FE lock operates only in Creative Zone modes, and the camera's AE lock button functions as an FE lock button.

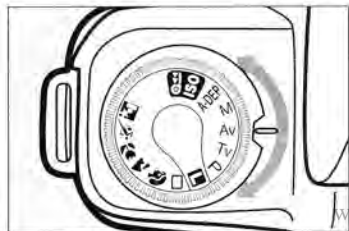

- 1 Turn the Command Dial to a Creative Zone mode.
- 2 Check that the Speedlite's lamp is lit.
 - The flash mode can be either normal or high-speed sync (FP flash). FE lock will work with either mode.

www.butkus.us

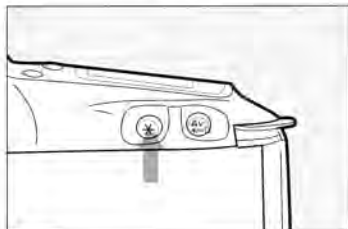
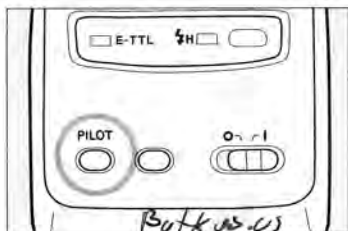

3 Aim the focusing point where you want to achieve focus and press the shutter button halfway to focus. Keep pressing the shutter button halfway.

4 Aim the partial metering circle over the subject where you want to lock the flash exposure, then press the FE lock button.

- The Speedlite fires a preflash and remembers the required flash amount.
- In the viewfinder, the ✳ symbol is displayed together with the $\frac{1}{2}$ or $\frac{1}{4}$ symbol.
- If the $\frac{1}{2}$ symbol in the viewfinder blinks, the subject is outside the effective range of the Speedlite. This may result in underexposure. Reduce the distance between the subject and camera until the symbol stops blinking after the FE lock button is pressed.
- The FE lock button remains effective for 16 sec. after it is released. The FE lock setting is therefore still effective during this time.

5 Press the shutter button completely to take the picture.



Using a Non-EX-Series Speedlite

If the camera is used with a non-EX-series EOS-dedicated Speedlite (540EZ, 430EZ, 420EZ, or 300EZ, etc.), the 3-zone A-TTL or TTL autoflash system will operate. Flash pictures (even with multi-flash accessories) can still be taken as easily as normal autoexposure pictures.

VI. Reference

This Reference section is provided to enable you to better understand your camera and take full advantage of its capabilities.

Basic terminology, a troubleshooting guide, accessories guide, and other information are covered.

Basic Terminology

Shutter speed

The shutter speed is the length of time the camera's shutter curtain opens to expose the film to the light coming through the lens. The shutter speed displayed on the camera's LCD panel and in the viewfinder ranges from 30 to 1/2000 sec. and bulb.

Aperture

The aperture (or f-number) indicates the size of the aperture opening in the lens. The aperture opening is adjusted by several aperture blades which open and close to adjust the aperture diameter. The aperture setting displayed on the camera's LCD panel and in the viewfinder can range anywhere from 1.0 to 32, depending on the lens attached to the camera. The larger the f-number, the smaller the aperture. And the smaller the f-number, the larger the aperture.

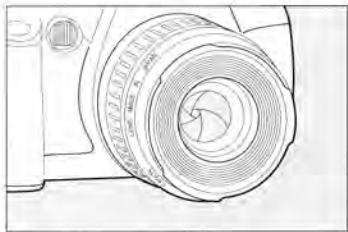

ISO film speed

The ISO film speed indicates the film's sensitivity to light. The higher the film speed, the more sensitive the film is. The more sensitive the film is, the less light is required to obtain a correct exposure. Therefore, a high-speed film is suited for low-light situations. The ISO film speed is set in accordance with standards set by the International Standards Organization (ISO).

A film speed from 6 to 6400 can be set with the camera. The film speed is displayed on the LCD panel and in the viewfinder.

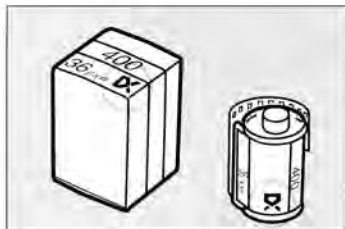

Depth of field

This is the range in front of and behind the plane of optimum focus where acceptable focus can be achieved. The smaller the aperture (the larger the f-number), the deeper the depth of field will be. And the larger the aperture (the smaller the f-number), the shallower the depth of field will be.

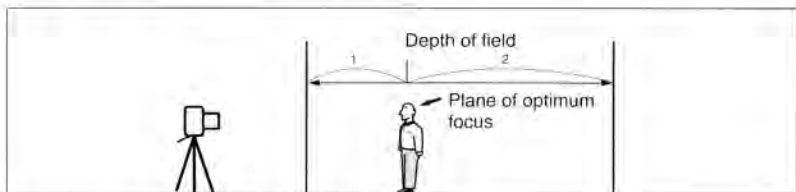

The depth of field is affected as described below:

- (1) A smaller aperture (a larger f-number) increases the depth of field.
- (2) A lens with a shorter focal length increases the depth of field.
A wide-angle lens obtains a deeper depth of field than a telephoto lens.
- (3) A longer distance between the camera and subject increases the depth of field.
- (4) The depth of field behind the plane of optimum focus is longer than the depth of field in front of the plane of optimum focus.





Troubleshooting Guide

If there is a problem, first refer to this Troubleshooting Guide. If the problem still persists, take your camera to your nearest Canon Service Center. Canon Service Centers are listed on the back of this booklet.

Problem	Probable Cause	Solution	Page No.
1. Nothing is displayed on the LCD panel.	The batteries are exhausted.	Replace the batteries with new ones.	10
	The batteries have been installed incorrectly.	Install the batteries correctly.	10
2. The shutter does not release.	The film has not been loaded correctly. (The frame No. is not displayed on the LCD panel.)	Load the film correctly.	14
	Rewound film is still in the camera. (The frame counter on the LCD panel is blank.)	Take out the film cartridge and load a new roll of film.	14
	Focus has not been achieved. (The in-focus indicator in the viewfinder is blinking.)	Press the shutter button halfway until focus is achieved. If focus still cannot be achieved, set the focus mode switch on the lens to MF (or M on some lenses) and focus manually with the focusing ring.	12
3. The photograph is out of focus.	The focus mode switch on the lens was set to MF (or M on some lenses) (Manual Focus).	Set the focus mode switch on the lens to AF (Autofocus).	12
	The shutter speed was too slow to prevent blur caused by camera shake.	Press the shutter button without shaking the camera or use a faster shutter speed.	13
4. Only  blinks or appears on the LCD panel.	The battery level is very low.	Replace the batteries with new ones and check that the battery level is displayed on the LCD panel.	11
	The camera is not operating properly.	Press the shutter button halfway to return the camera to normal. * If  is still displayed even after the above solutions are executed repeatedly, the camera needs repair. Take it to the nearest Canon Service Center.	11 Back cover

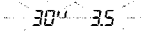
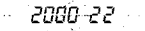
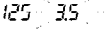
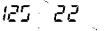
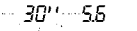
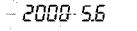
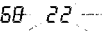
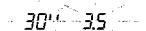
Exposure Warnings

Command Dial Mode	Blinking Display (Warning)	Description	Countermeasures
P	 30" shutter speed and lens' maximum aperture	The subject is too dark.	Use flash.
	 1/2000 shutter speed and lens' minimum aperture	The subject is too bright.	Attach a neutral density filter to the lens.
Tv	 Lens' maximum aperture	The picture will be underexposed.	Turn the Main Dial to set a slower shutter speed.
	 Lens' minimum aperture	The picture will be overexposed.	Turn the Main Dial to set a faster shutter speed.
Av	 30" shutter speed	The picture will be underexposed.	Turn the Main Dial to set a larger aperture.
	 1/2000 shutter speed	The picture will be overexposed.	Turn the Main Dial to set a smaller aperture.
A-DEP	 Current aperture	The desired depth of field cannot be obtained.	1) Move away from the subject and try again. 2) If a zoom lens is used, use the shortest focal length.
	 30" shutter speed and lens' maximum aperture	The subject is too dark.	Use flash.
	 1/2000 shutter speed and lens' minimum aperture	The subject is too bright.	Attach a neutral density filter to the lens.

Butkus's

Feature Availability Table

Command Dial Mode	Autofocus		Focusing Point Selection		Film Advance		Metering Mode			Flash	
	One-Shot AF	AI Servo AF	Auto	Manual	Single	Continuous	Evaluative	Center-weighted averaged	Partial	Automatic Firing	Manual
		●	●		●		●			●	
	●		●			●	●			●	
	●		●		●		●				—
	●		●		●		●			●	
		●	●			●	●				—
	●		●		●		●			●	
P		●	○	○		●	●		(●)*		●
Tv		●	○	○		●	●		(●)*		●
Av		●	○	○		●	●		(●)*		●
M		●	○	○		●		●	(●)*		●
A-DEP	●		●		●		●		(●)*		●

●: Set automatically. ○: User-selectable. * Available only while the partial metering button is pressed.

One-Shot AF: The exposure setting (shutter speed and aperture) is set when focus is achieved. The picture cannot be taken unless the subject is focused.

AI Focus AF: Normally, One-Shot AF is set. However, if the subject starts to move, the camera detects the subject's movement and switches to AI Servo AF automatically. The exposure setting is set right before the picture is taken.

AI Servo AF: In this mode, the camera focuses continuously. Suited for a moving subject. The exposure setting is set right before the picture is taken.

Continuous advance: This is for taking continuous shots. While the shutter button is held down, the camera can shoot continuously as fast as 1 frame per second.

Evaluative metering: The difference in the brightness level between the subject and background, subject size, etc., are taken into account to set a suitable exposure setting.

Partial metering: The exposure setting is based on the brightness of the area covered by the partial metering circle on the viewfinder screen.

Centerweighted averaging metering: The metering is weighted at the center and then averaged for the entire scene.

AF Modes and Film Advance Modes

Film Advance Mode	One-Shot AF	AI Servo AF
Single	The shutter cannot be released until focus is achieved. When focus is achieved, AF is locked. In the evaluative metering mode, the exposure setting (set right before the picture is taken) is also locked.	Autofocus tracks the moving subject, and the exposure setting is set when the shutter is released.
Continuous	The same conditions above apply during continuous shooting. (At about one frame per second.)	The same conditions above apply during continuous shooting. Autofocusing operates during continuous shooting. (At about one frame per second.)

Major Accessories (Sold Separately)



Grip GR-80TP

Grip GR-80TP comes with a hand strap and serves as a camera grip for holding ease. It can also unfold as a mini-tripod.



Eyepiece Extender EP-EX15

When attached to the camera, this eyepiece extender extends the EOS camera's eye relief by 15 mm. The viewfinder magnification also becomes 0.5x.



Dioptic Correction Lens E

Attaching a dioptic correction lens E on the eyepiece allows near- or far-sighted users to see the viewfinder clearly without eyeglasses. The camera's eyepiece lens is -1 diopter. Ten dioptic correction lenses are available. When choosing a dioptic correction lens, attach it to the eyepiece and look through the viewfinder to see if it suits your vision.

* The number on the dioptic correction lenses indicates the diopter when it is attached to the camera's eyepiece. It is not the diopter of the dioptic correction lens itself.



Remote Switch RS-60E3

Dedicated cable release for use with a tripod-mounted camera to prevent camera shake during close-ups and bulb exposures. Connects to the camera's remote control jack.



Battery Pack BP-8

An external battery pack which uses size-AA batteries. Convenient when lithium batteries are not readily available.



EX-Series Speedlites

These include the high-output 380EX (Guide No. 38 at ISO 100 in meters) and the compact 220EX (Guide No. 22 at ISO 100 in meters). Either can be mounted on the camera's hot shoe.

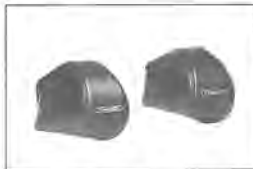

Camera Case EH8-L and EH8-LL

Dedicated case which accommodates the camera with any of the following lenses attached:

EH8-L: EF 35-80mm f/4-5.6 USM
EF 35-105mm f/4.5-5.6 USM

EH8-LL: EF 28-80mm f/3.5-5.6 IV USM
EF 80-200mm f/4-5.6 USM



When using an external flash unit, an EOS-dedicated Speedlite is recommended. Using a flash unit (equipped with several contacts on the hot shoe foot) dedicated to a different-brand camera or using a high-voltage battery-type flash unit or accessories may result in camera misoperation or malfunction.

Handling Precautions

Camera Care

1. This camera is not waterproof and cannot be used in rain or underwater. If the camera gets really wet, consult your nearest Canon Service Center. Wipe off any water droplets with a dry cloth. If the camera has been exposed to salty air, wipe with a well-wrung damp cloth.
2. Do not leave the camera in places prone to excessive heat such as in a car on a sunny day. Excessive heat can cause the camera to malfunction.
3. The camera contains high-voltage circuitry. Never attempt to disassemble the camera.
4. Use only a blower brush to remove any dust on the lens or in the film compartment. Do not use an organic solvent-containing cleaner to clean the camera body or lens. For stubborn dirt, consult your nearest Canon Service Center.
5. If the camera is not to be used for an extended period, remove the battery. Store the camera in a well-ventilated, cool, dry place. During the storage period, release the shutter a few times once in a while.
6. Avoid storing the camera in a laboratory, cabinet, etc., where corrosive chemicals are present.
7. If the camera has not been used for an extended period or if the camera is to be used for an important event, check all the camera operations yourself or take it to the nearest Canon Service Center.

LCD Panel

In time, the camera's LCD (liquid-crystal display) panel indications may become light and difficult to read. If this happens, have it replaced (at cost) by a Canon Service Center.

At high temperatures, the display response of the LCD panel may become slower. And at 60°C or higher temperatures, the display may blacken. In either case, the display will return to normal at room temperature.

Lithium Batteries

The camera operates on two DL123A (or CR123A) lithium batteries. Check the battery level in the following cases:

1. After replacing the batteries.
2. After not using the camera for an extended period.
3. The shutter does not work.
4. The camera is being used in a low-temperature environment.
5. Before using the camera for an important event.

Also note the following:

- Before installing the batteries, wipe the battery contacts to remove any fingerprints and smudges. This is to prevent faulty connections and corrosion.
- Never disassemble or recharge the batteries. Also, never store the batteries in high-temperature places or short circuit the battery contacts or toss the battery into a fire.
- Although the batteries work well even at low temperatures, battery performance may suffer slightly at freezing temperatures. In such a case, keep spare batteries warm in a pocket, etc., and use and warm the batteries alternately.

Low Battery Power

When only the  symbol blinks on the LCD panel, a picture can still be taken at the proper exposure. However, there may not be enough battery power to advance and rewind the film automatically. Replace with new batteries.

Lens

To avoid getting the lens surface and electronic contacts scratched, attach the rear lens cap to the detached lens or always put down the lens with the rear end up.

Major Specifications

Type	35mm autofocus/autoexposure single-lens reflex camera with focal-plane shutter, built-in motor drive, built-in flash, and quartz date back.*
Picture size	24 mm × 36 mm
Compatible lenses	Canon EF lenses
Lens mount	Canon EF mount (Fully-electronic control)
Picture coverage	90% vertical, 90% horizontal.
Magnification	0.7 X (with 50mm lens focused at infinity).
Standard diopter	-1 diopter. 18.5mm eye relief.
Focusing screen	Fixed, New Laser-matte screen with focusing points and partial metering circle.
Exposure modes	<ul style="list-style-type: none"> ① Program AE (shiftable) ② Shutter speed-priority AE ③ Aperture-priority AE ④ Automatic depth-of-field AE ⑤ Full Auto (non-shiftable) ⑥ Programmed Image Control modes (5) ⑦ Flash AE: E-TTL program flash AE with Speedlite 220EX or 380EX, TTL program flash AE with the built-in flash, A-TTL and TTL program flash AE with other EOS-dedicated Speedlites ⑧ Metered manual.
Camera-shake warning	Provided with Full Auto and Programmed Image Control modes (except Night Scene mode). Shutter speed display blinks if the shutter speed is slower than the reciprocal of the lens focal length by more than one-half stop.
Metering range	EV 2-20 (at 20°C and normal humidity with a 50mm f/1.4 lens, ISO 100)
ISO film speed range	ISO 6-6400 (ISO 25-5000 for DX-coded film)
Exposure compensation	±2 stops in half stops (unavailable in Programmed Image Control modes)
Autobracketing	±2 stops in half stops. Sequence: Correct exposure, underexposure, and overexposure in single-frame or continuous shooting mode.
Multiple exposures	Max. 9 settable.

* QD models only

www.butkus.us

AF control	TTL-CT-SIR (Through-the-Lens Cross-Type Secondary Image Registration) with multiple BASIS (Base-Stored Image Sensor). ① One-Shot AF: AF locks when focus is achieved. Shutter can be released only when focus is achieved. ② AI Focus AF: Switches between One-Shot AF mode and AI Servo AF automatically. ③ Manual focusing: Enabled by setting the lens' focus mode switch to "M" and turning the focusing ring.
AF working range	EV 1.5-18 (at ISO 100, standard chart)
Focusing point selection	① Automatic: Camera-selected. ② Manual: User-selected.
AF-assist beam	Built-in AF-assist beam emitted automatically
Shutter	Vertical-travel, focal-plane shutter with all speeds electronically-controlled.
Shutter speeds	30 to 1/2000 sec. (in half steps) and bulb. X-sync at 1/90 sec.
Self-timer	Electronically-controlled for 10-sec. delay.
Film loading	Automatic. After film is loaded and the back is closed, the film is pre-wound.
Film advance	Automatic. ① Single-frame ② Continuous (Max. 1 frame per sec.)
Film rewind	Automatic at the end of the roll. Midroll rewind possible.
Built-in flash	Built-in, retractable flash head in the pentaprism with TTL autofocus system, serially controlled. ① Guide No. 12 (in meters at ISO 100) ② Recycling time: Approx. 2 sec. ③ Flash coverage: 28mm lens covered.
Flash contacts	X-sync for direct connection on hot shoe.
Power source	Two DL123A (or CR123A) lithium batteries.
Battery check	Battery level displayed automatically when Command Dial is set to any mode except the Function Set Zone.
Dimensions (mm)	145.7 (W) × 92 (H) × 61.9 (D)
Weight	370 g (Body only, excluding batteries)

Lens		EF28 - 80mm F3.5 - 5.6 IV USM	EF35 - 80mm F4 - 5.6 III	EF75 - 300mm F4 - 5.6 II
Angle of view	Diagonal extent	75° - 30°	63° - 30°	32°11' - 8°15'
	Vertical extent	46° - 17°	38° - 17°	18°11' - 4°35'
	Horizontal extent	65° - 25°	54° - 25°	27° - 6°50'
Lens construction (elements/groups)		10 elements in 10 groups	8 elements in 8 groups	9 elements in 13 groups
Min. aperture		f/22 - 32	f/22 - 32	f/32 - 45
Focusing distance range		0.38m - ∞	0.4m - ∞	1.5m - ∞
Max. magnification and picture area		28mm	35mm	75mm
		0.10 (255×393mm)	0.11 (228×352mm)	0.06 (372×558mm)
		80mm	80mm	300mm
		0.26 (91×135mm)	0.23 (104×154mm)	0.25 (95×142mm)
Filter size and attachable quantity		58mm, 1	52mm, 1	58mm, 1
Length × Max. diameter		71,2×66.4mm	65×63.5mm	71×122.1mm
Weight		200g	175g	480g

- Specifications are subject to change without notice. All specifications have been obtained through Canon's Standard Test Methods.